

**PILAR  
65" ACRYLIC  
OVAL TUB**

Cat. No.  
ATOVN65FIG



L: 65"  
W: 29-1/2"  
H: 22-1/4"

Water depth: 17" to top of tub  
Water depth: 14" to overflow  
Overflow slot: 3" under tub rim

**The following is recommended for ATOVN65F tubs:**

- Faucets: **#4602, 4022 or 4025**
  - Rigid freestanding Supplies: **#4502**
  - Freestanding Faucets: **#7932, 7934**
- (Do Not Need Bath Supplies)**

Gallon Capacity with OF: 39  
Shipping Weight: 128 lbs.  
Empty Weight: 76 lbs.  
Filled Weight with OF: 402 lbs.

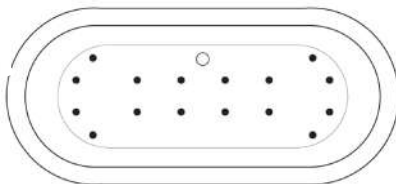

(Air jet configuration if system is added, more info on page 2.)

**Features:**

- ▶ Acrylic construction for lighter weight
- ▶ Air between sheet provides insulation to help retain warmth
- ▶ Overflow slot with integrated drain
- ▶ Drain and overflow covers included (available in 7 finishes)
- ▶ No faucet holes with tap deck
- ▶ IAPMO certified
- ▶ For use with a freestanding tub filler or faucet mounted on the bathroom wall
- ▶ Option to add foam insulation between tub walls available
- ▶ 1-3/4" wall thickness
- ▶ **New:** Air jet system now available, more info on page 2

**Finishes:**

- |                              |                           |
|------------------------------|---------------------------|
| <b>CP</b> Polished Chrome    | <b>PB</b> Polished Brass  |
| <b>BN</b> Brushed Nickel     | <b>PN</b> Polished Nickel |
| <b>ORB</b> Oil Rubbed Bronze | <b>MB</b> Matte Black     |
| <b>WT</b> White              |                           |



**Custom Colors Available** (inside of tub is always white enamel):  
Painted bathtubs are considered "special order" and are not returnable  
\$160 Bisque or Black \$250 Designer Color

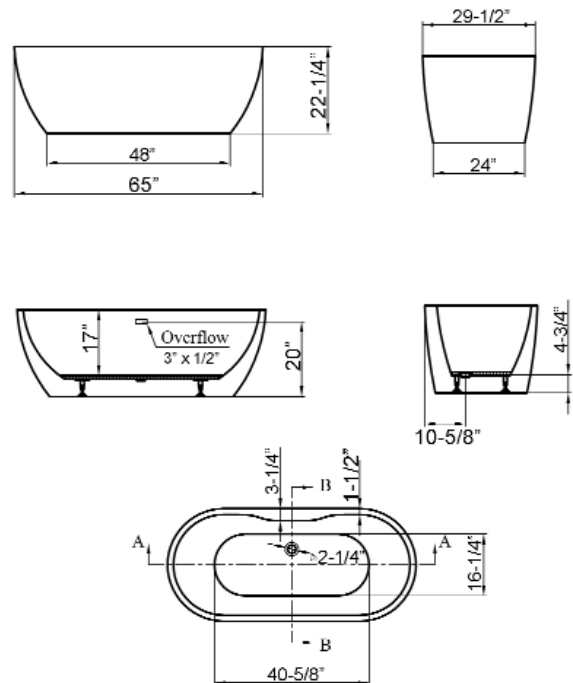

Dimensions of fixture are nominal and specifications subject to change without notice.

# BATHTUB AIR JET KIT

Cat. No.  
AIR KIT 1, AIR KIT 2

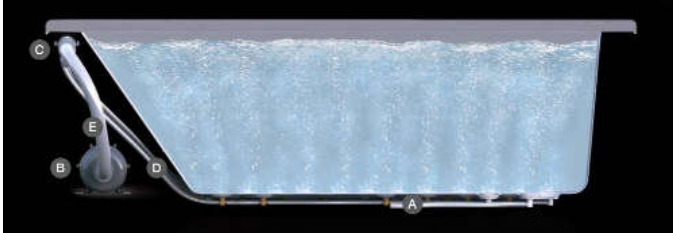

- A** AIR JET - Bottom air jets for maximum bubble action.
- B** BLOWER - The heart of the massage system.
- C** MANIFOLD - Double back flow security prevention device.
- D** FLEXIBLE PVC HOISING - IAPMO certified.
- E** MAIN AIR INTAKE HOSE - High temperature and pressure resistant.

## Features:

- ▶ 750 Watt blower motor operates system
- ▶ 300 Watt air heater warms air
- ▶ System powered by 120V
- ▶ 16 brass air jets placed in bottom of tub
- ▶ Each air jet has 24 holes
- ▶ Air jet caps available in white (AIR KIT 1) or black (AIR KIT 2)
- ▶ Includes 1 1/4" x 3' main air hose plus 1 1/4" x 9' extension hose
- ▶ Automatic system purge after each use
- ▶ Automatic safety timer turns off system after 20 minutes
- ▶ Includes water tight remote control
- ▶ Compatible with most acrylic, copper and resin tubs with no feet
- ▶ Not available with cast iron tubs or tubs with feet

**Air Kit is installed in tub before shipment**

## INSIDE TUB VIEW - WILL VARY BY TUB DESIGN



Air Jet



Remote

**Oval bathtub**  
Sample jet configuration

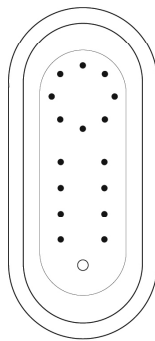

with end drain

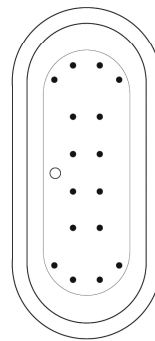

with center drain

**Rectangular bathtub**  
Sample jet configuration

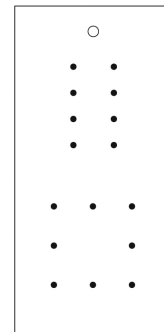

with end drain

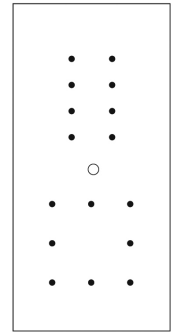

with center drain

**Round bathtub**  
Sample jet configuration

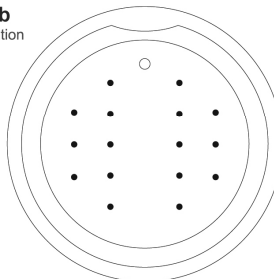

These diagrams are general representations.  
Jet placement may vary dependent on tub shape

### Features:

(16) Maxi Air Jets



Elbows for air jets



Tees for air jets