



Contemporary Lighting

PRODUCT NAME: LARMES

ITEM NUMBER: E23129-18

Please consult your electrician for hanging fixture and wiring.

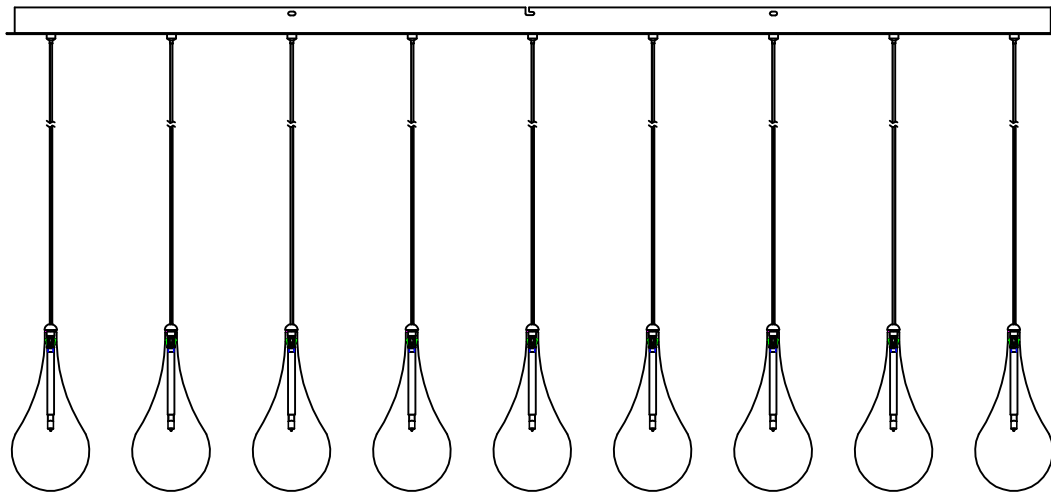

WARNING: Wires need to be connected to driver found in canopy and should not be connected directly to power source or a short may occur

Bulbs (Included): 9 x 1.5W G4 LED

IMPORTANT: Turn off the power at the main fuse or circuit breaker box before starting installation

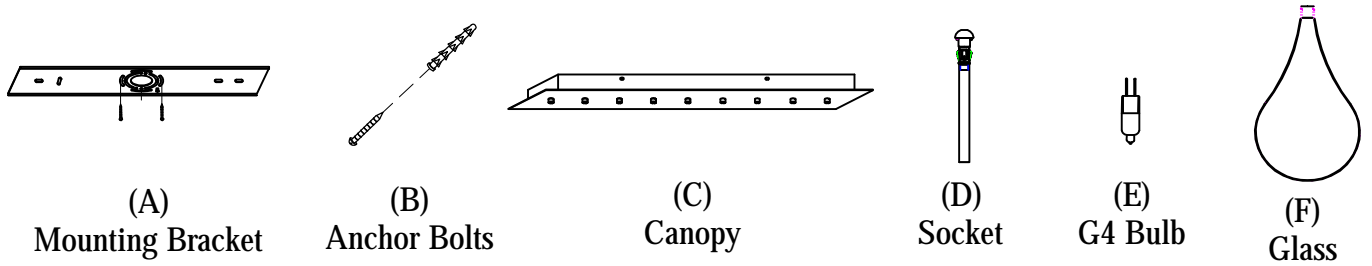

Locate all hardware & components before discarding packaging

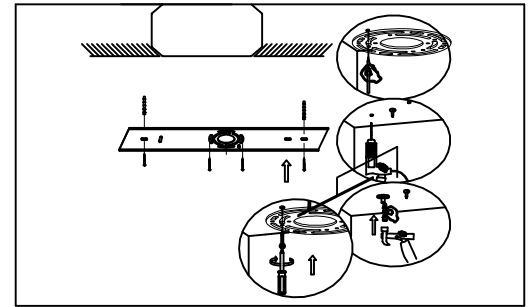
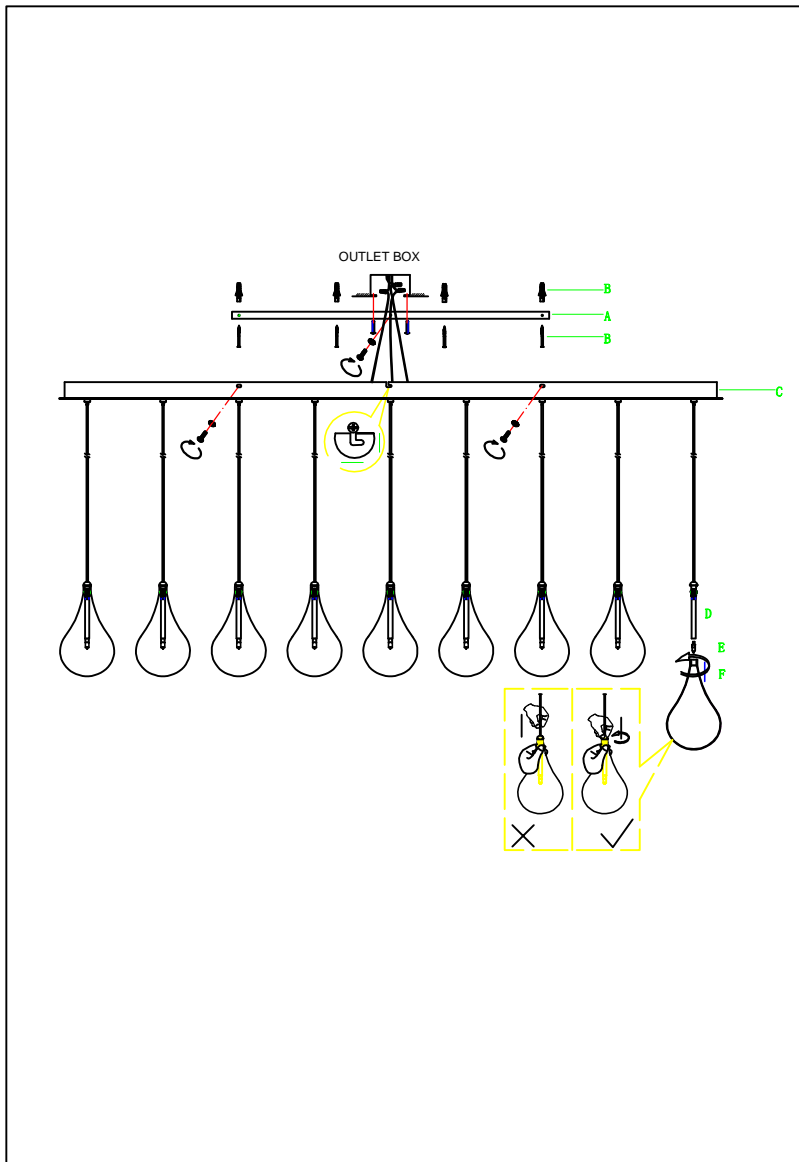

Step.1: Remove mounting bracket (A) and install to electrical box. Mark where anchors meet ceiling, remove mounting bracket from ceiling, and then drill holes using 3/16" drill bit where marked (B). Install mounting bracket and attach anchors to secure bracket at ends.

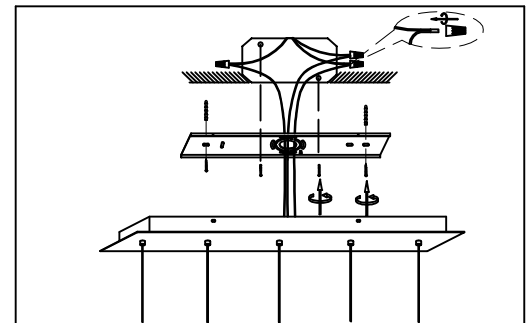

2.) Wire fixture to wires in outlet box. Green wire is for Ground.

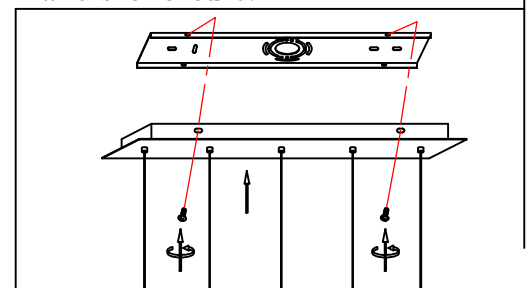

3.) Tighten screws on the sides of the canopy (C) to secure the fixture.

4.)

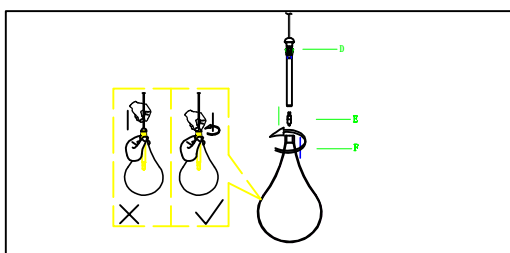

Step.4: Install G4 bulb (E) provided. Gently turn glass (F) onto socket (D) to secure.

Cleaning & Care:

Clean with soft cloth and a mild detergent. Do not use abrasive cleaner.