

DESIGN COPYRIGHT – 12/21/2022
ALL RIGHTS RESERVED AND MAY
NOT BE DUPLICATED WITHOUT OUR
WRITTEN PERMISSION

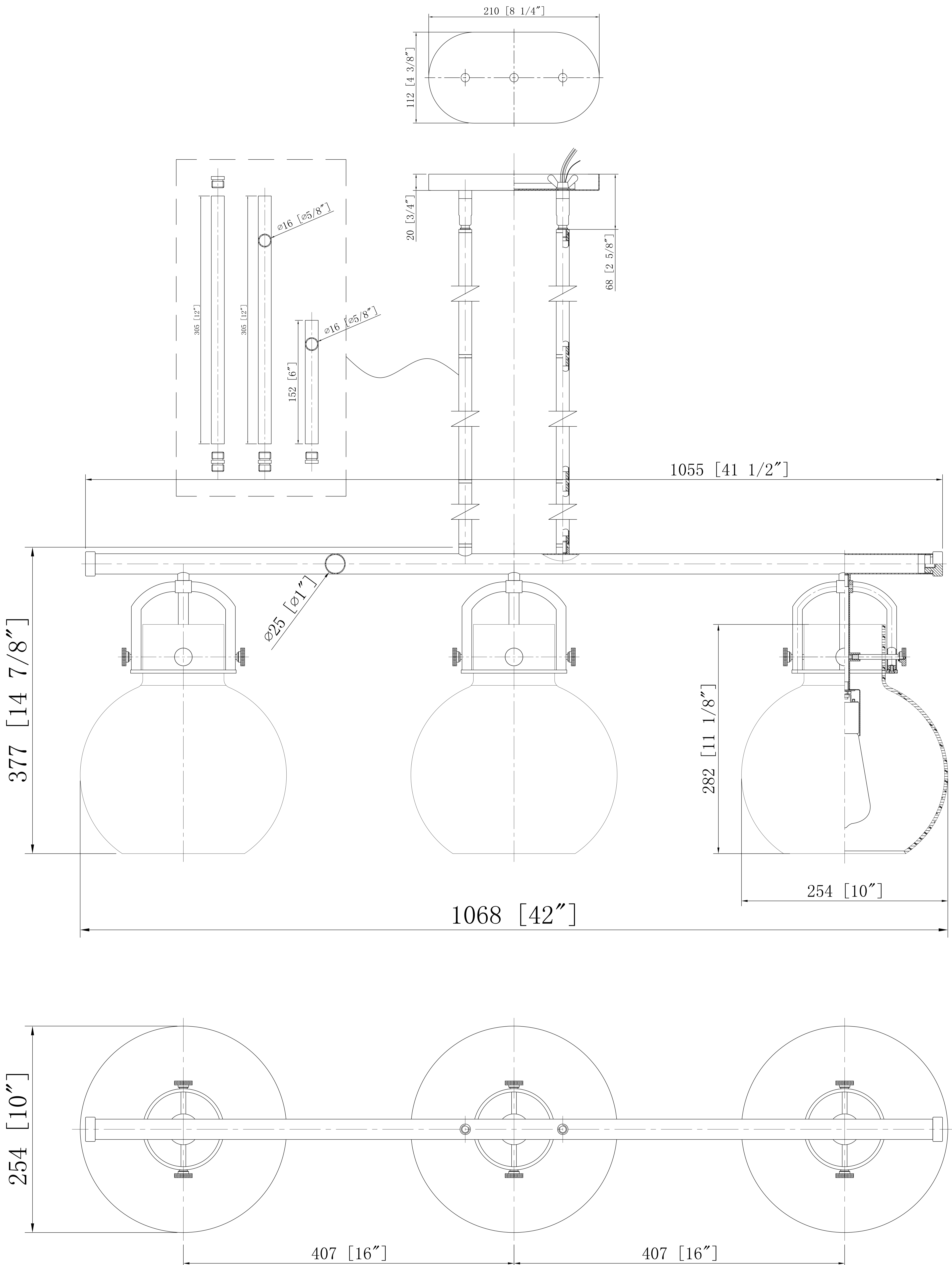

ITEM: 410-3I-10