

INSTALLATION INSTRUCTIONS

Item# P1237

READ AND SAVE THESE INSTRUCTIONS

WARNING! SHUT POWER OFF AT FUSE OR CIRCUIT BREAKER.

AVERTISSEMENT! COUPER LE COURANT AU NIVEAU DES FUSIBLES OU DU DISJONCTEUR.

ASSEMBLING THE FIXTURE (Fig.1)

- 1 Shut off power at the fuse box or circuit breaker. If necessary, remove the old fixture including the mounting hardware.
- 2 Carefully remove the fixture from the carton and check that all parts are included as show in Figure 1.
- 3 Loosen screws (C) and separate mounting plate (A) from fixture (D).
- 4 Attach mounting plate (A) to the junction box with junction box screws (B) (size: 8-32*1/2"L). The side of the mounting plate marked "GND" must be face out.

CONNECTION THE WIRES (Fig. 2)

- 5 Connect the electrical wires as shown in Fig.2, making sure that all wire nuts are secured. If your outlet has a ground wire (green or bare copper), connect the fixture's ground wire to it. Otherwise, connect the fixture's ground wire directly to the circular strap using the green screw provided. Tuck the wire connections neatly into the junction box.

FINISHING THE INSTALLATION (Fig. 1)

- 6 Align fixture (D) and clip (E) onto mounting plate (A) and secure with screws (C).
- 7 To prevent moisture from entering the outlet box and causing a short circuit, use clear caulking (i.e. Indoor/Outdoor silicone sealant) to outline the outside of fixture back plate where it meets the wall leaving a space at bottom to allow moisture a means to escape (Fig.3).

Your installation is now complete. Return power to the junction box and test the fixture.

CAUTION /ATTENTION: When handling the fixture, do not apply pressure to the LED. Hold the fixture by the base or back plate (G) only.

Replacing LED module (Fig. 4)

The LED module can be replaced by a qualified electrician without cutting of wire and without damage to any decorative element to which the fixture is attached. See installation steps for more details (Fig. 4)

Warning: Turn off power at the circuit breaker before replacing LED module.

- a. To remove the fixture from the wall, loosen screws (C) and remove fixture (D) and clip (E) from mounting plate (A). Remove the wire connectors and place the fixture on a clear flat surface. (Fig. 1)
- b. Loosen screws (Q) and remove rubber washers (R) to separate glass holder (P) and glass shade (O) from back plate (G).
- c. Loosen screws (N), remove rubber washers (M) and hex nuts (F) to separate glass panel (L) from LED housing (I). (Fig. 4)
- d. Loosen screws (K) and hex nuts (H) and carefully remove LED module (J) from LED housing (I).
- e. Reverse steps a-d for installing the new LED module.

Note: The LED module should be provided by a specified supplier.

IMPORTANT: Fixture should be installed by a qualified electrician to ensure proper wiring and installation.
Dimmable with C-L (CFL & LED) type and Incandescent/Halogen type dimmers



Fig. 1

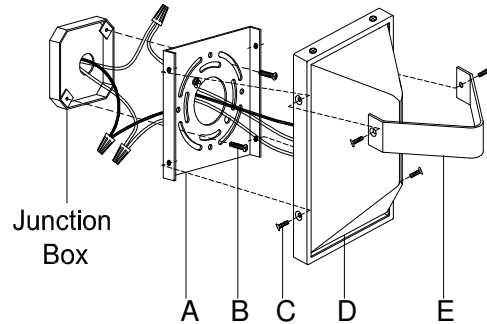

Set# A-021-185120

- Mounting Plate
- Ground Screw
- Mounting Screw*2

Fig. 2

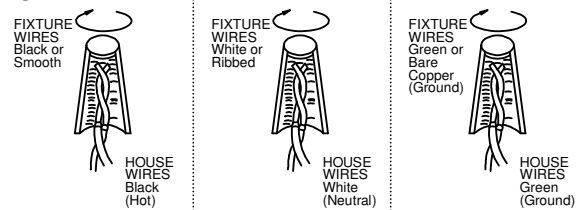

Fig. 3

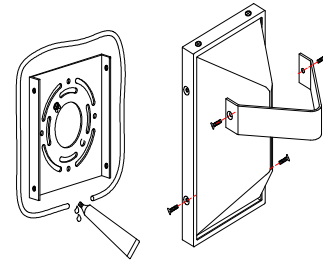

Fig. 4

