

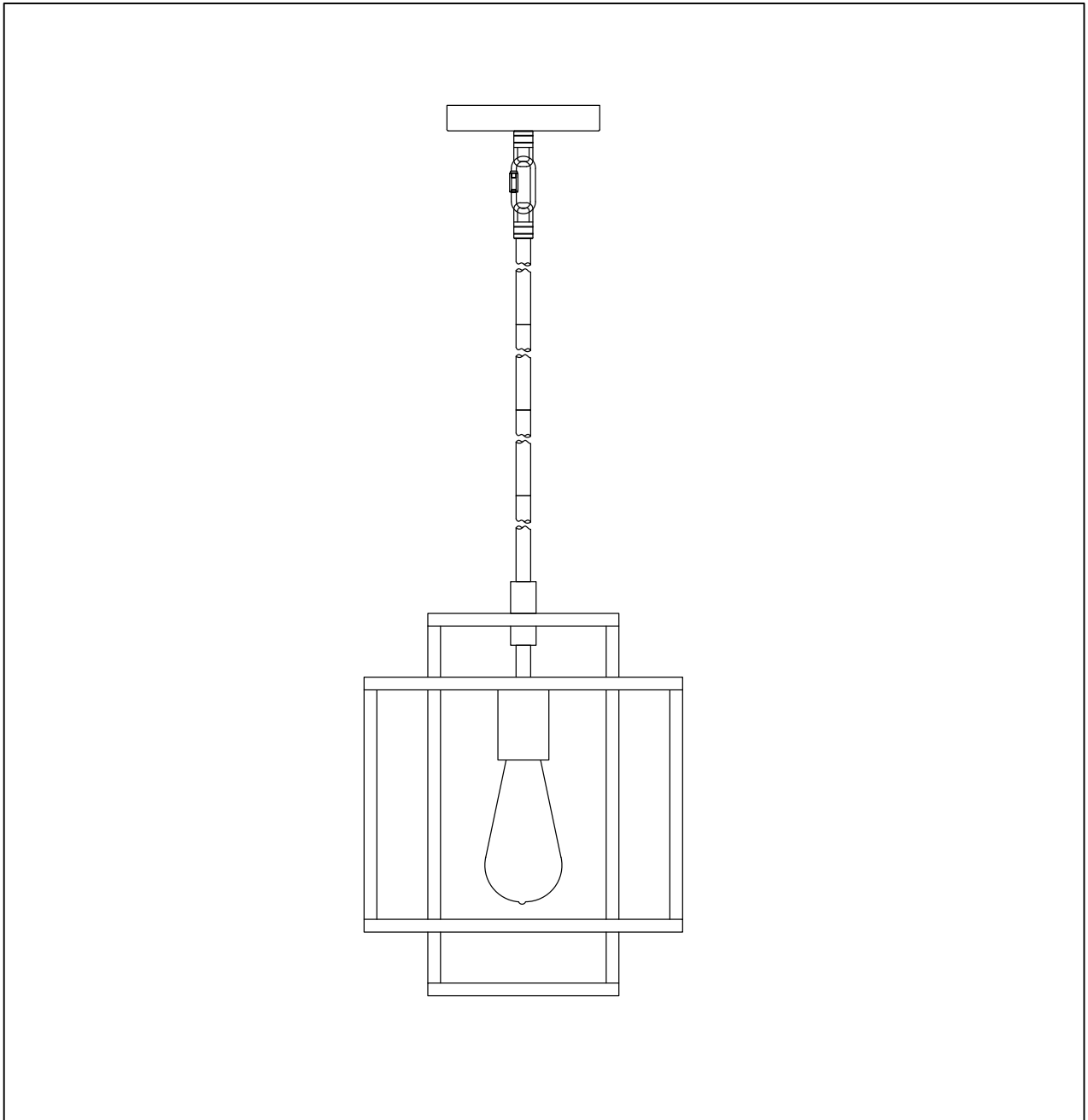

PRODUCT NAME: Liner 1-Light Pendant
ITEM NUMBER: 10246

Please consult your electrician for hanging fixture and wiring.



Bulbs (Not Included) : E26 1*60W ST64

IMPORTANT: Turn off the power at the main fuse or circuit breaker box before starting installation

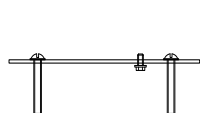

Bracket(A)



Mounting Screws(B)



Finial(C)

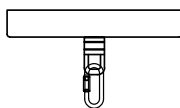

Canopy(D)

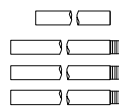

Stems(F)

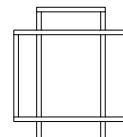

Fixture(G)



Bulb(H)

Locate all hardware & components before discarding packaging

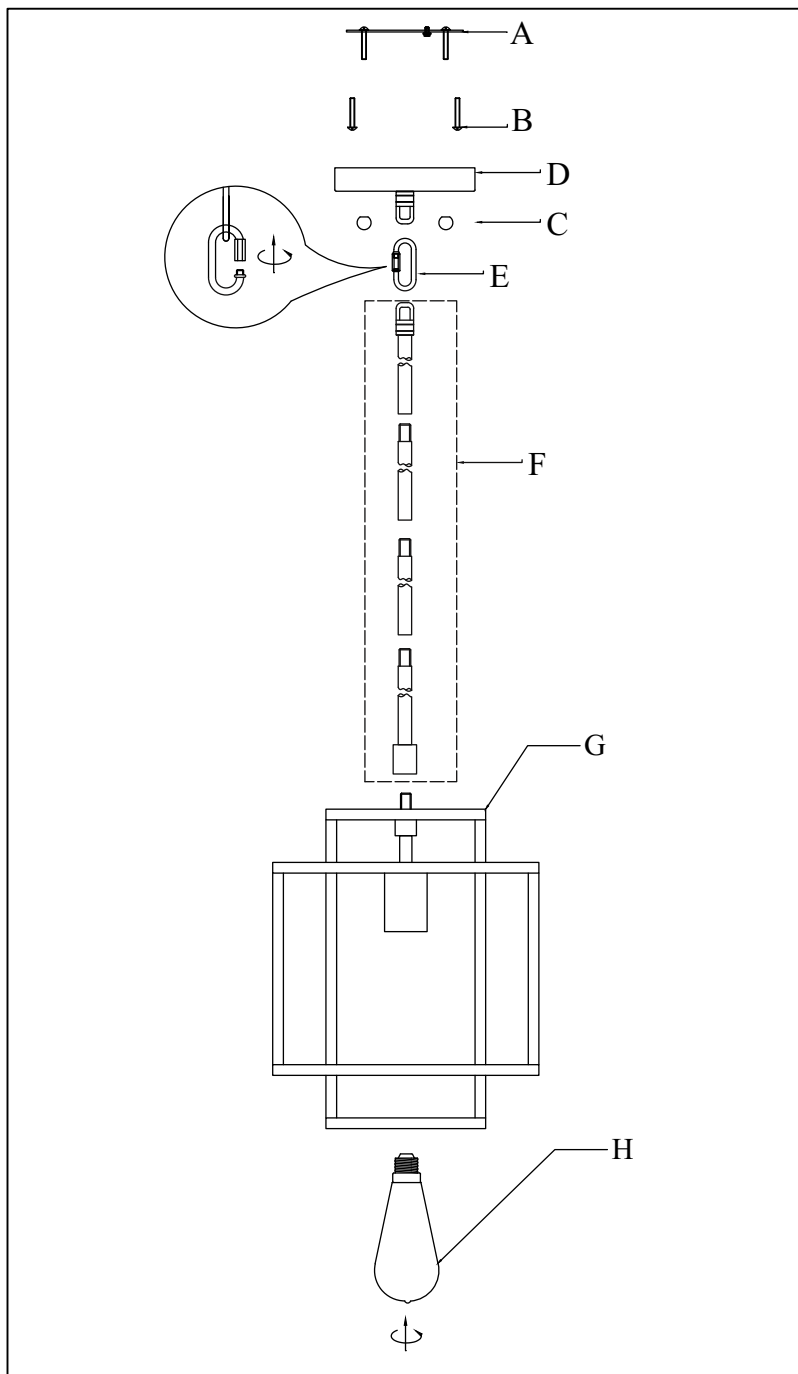

Cleaning & Care:

Clean with soft cloth and a mild detergent.
Do not use abrasive cleaner.

1.)

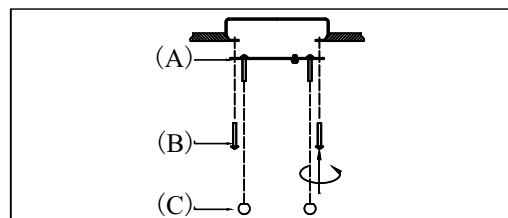

Step1 : Remove mounting bracket from fixture and install to electrical box.

2.)

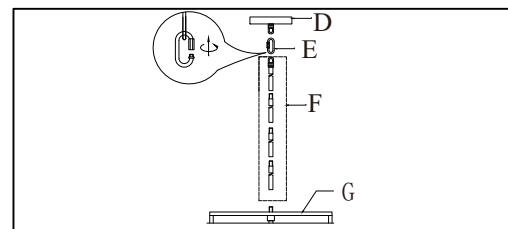

Step.2: Run wire through stems and combine stem lengths to meet desired mounting height.

3.)

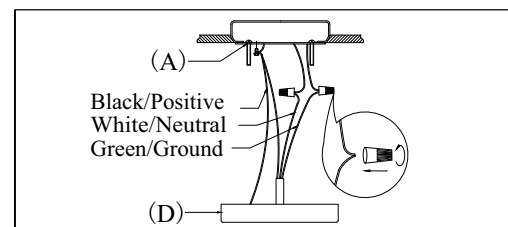

Step3 : Wire fixture to wires in outlet box. Green wire is for Ground.

4.)

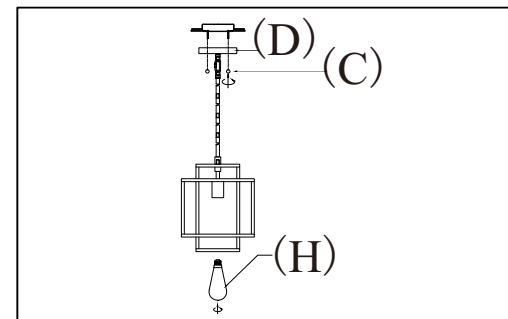

Step4 : Install fixture to bracket and tighten screws at the ends of the canopy to secure. Install bulb into Socket.