

INSTALLATION INSTRUCTION FOR FIXTURE #3043-560

**WARNING! SHUT POWER OFF AT FUSE OR CIRCUIT BREAKER.
AVERTISSEMENT! COUPER LE COURANT AU NIVEAU DES FUSIBLES OU DU DISJONCTEUR.**

MOUNTING THE FIXTURE (FIG. 1)

1. Shut off the power supply at the fuse box or circuit breaker. If necessary, remove the old fixture from wall. Including the mounting hardware.
2. Carefully remove the new fixture from the carton and check that all parts are included as shown in the illustration.
3. Thread the mounting nipple (C) into crossbar (A), then secure with spring washer and hex nut.
4. Attach the crossbar (A) to the outlet box using the mounting screws (B) (SIZE: #8-32N * L0.5"). The side of the crossbar (A) marked "GND" must face out.

CONNECTING THE WIRES (FIG. 2)

5. At this point, connect the electrical wires as shown in Fig. 2, making sure that all wire nuts are secured. If your outlet box has a ground wire (green or bare copper), connect the fixture's ground wire to it. Otherwise, connect the fixture's ground wire directly to the crossbar using the green screw provided.
6. Tuck the wire connections neatly into the wall outlet box.

ASSEMBLE THE FIXTURE (FIG. 1)

7. Attach the fixture body onto the outlet box by protruding mounting nipple (C) through mounting hole on the backplate (D) and secure with finial (E).
8. Install the T10 bulbs (H) into the sockets (G).
(DO NOT EXCEED THE MAXIMUM WATTAGE RATING!) (NE PAS DEPASSER LA PUISSANCE NOMINALE MAXIMALE!).
9. Slide the glass shades (I) (Part#G3045) into the cups (F).

Your installation is now complete. Return power to the junction box and test the fixture.

Fig.1

Set A-010
-Crossbar
-Ground Screw
-Mounting nipple

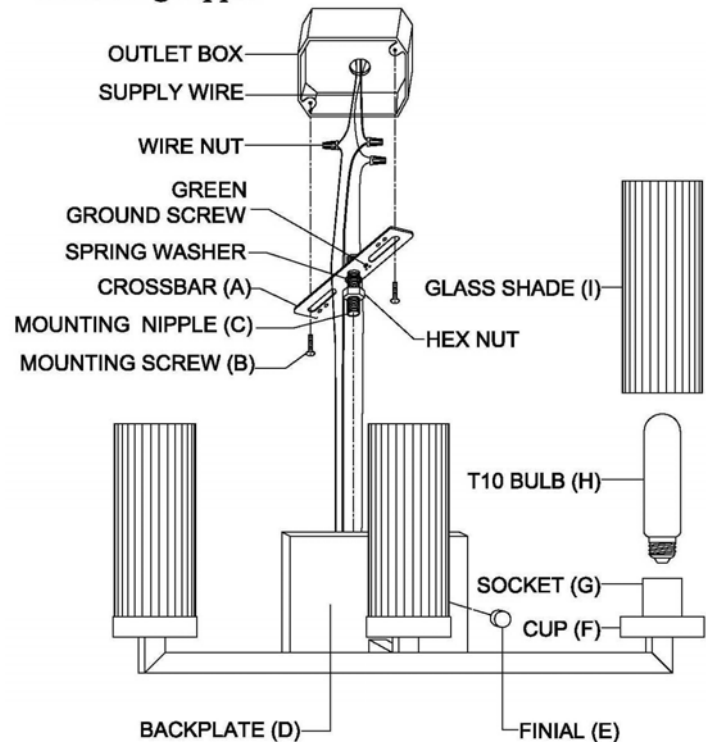

Fig.2

