

LEDRS10 - LED R SERIES OUTDOOR 10" ANGLE SHADE

This item can be converted to a pendant or wall sconce with purchase of separate compatible downrod or goose neck.

Please see compatible downrods and arms below:

- Compatible downrods: RS1, RS2, and RS3
- Compatible with arms: RGN10, RGN12, RGN13, RGN15, RGN22, RGN23, RGN24, RGN30, and RGN41
- Compatible with wire guard: RWG10



R SERIES

Dimensions

Width	10"
Height	11"
Wire Length	100"
Weight	2.51 lbs.

Finish & Material

Finishes	SB - Satin Black
Material	Metal

LED Light Engine

- 11W LED
- 90 CRI
- 800 Lumens
- 3000k
- 50,000 Hour Lifespan
- Constructed in Aluminum
- 5 Year Warranty
- Replaceable LED Module

Certification

UL Listed	Wet Location
-----------	--------------

Item Number

SKU'S	LEDRAS10-SB
-------	-------------

Note: All finishes on outdoor lighting must be properly maintained and treated. Therefore, we suggest cleaning with a regular application of finish preserving & renewing products such as Rejuvenate.

"Making the Desirable Affordable"

R SERIES OPTIONS

GOOSE NECKS - (WALL MOUNT)

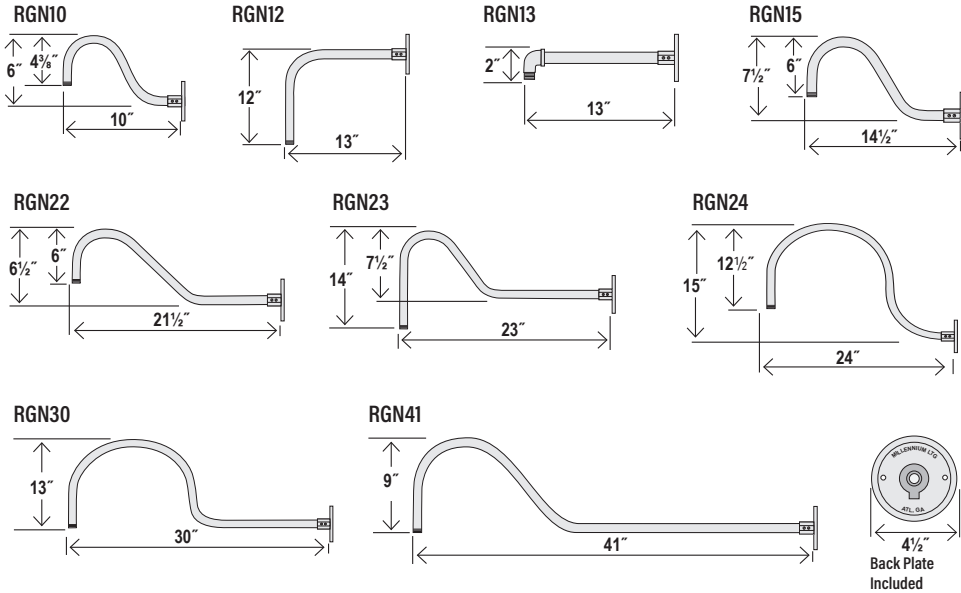

ID: 3/4"

FINISHES

ABR - Architectural Bronze
AL - Aluminum
ASB - Aluminum Painted Satin Black
GA - Galvanized
GY - Gray
NB - Navy Blue
NC - Natural Copper
SB - Satin Black
SG - Satin Green
SR - Satin Red
WH - White

STEMS AND CANOPY KITS - (CEILING MOUNT)

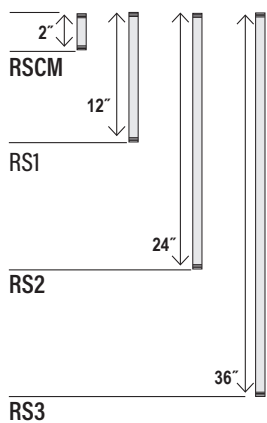

RSCK (25° Angle)

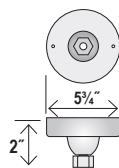

RSCKSS (45° Angle)

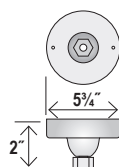

ID: 3/4"

FINISHES

ABR - Architectural Bronze
CP - Copper
GA - Galvanized
GY - Gray
NB - Navy Blue
SB - Satin Black
SG - Satin Green
SR - Satin Red
WH - White

STEM CONNECTORS

RC

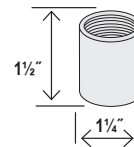

Accepts 3/4" stem

FINISHES

ABR - Architectural Bronze
AL - Aluminum
CP - Copper
GA - Galvanized
GY - Gray
NB - Navy Blue
SB - Satin Black
SG - Satin Green
SR - Satin Red
WH - White

WALL MOUNT SWIVELS

RSW

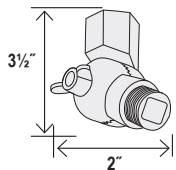

FINISHES

ABR - Architectural Bronze
CP - Copper
GA - Galvanized
SB - Satin Black
SG - Satin Green
SR - Satin Red
WH - White

WIRE GUARDS

RWG17

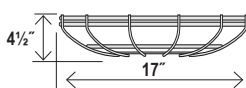

RWG14



RWG12

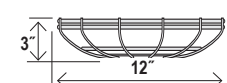

RWG10

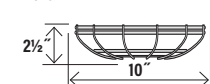

FINISHES

ABR - Architectural Bronze
GA - Galvanized
GY - Gray
NB - Navy Blue
SB - Satin Black
SG - Satin Green
SR - Satin Red
WH - White

R SERIES OPTIONS

1 LIGHT POST ADAPTERS

- Will work with any RLM shade
- Designed to fit standard 3" posts and pier mount bases
- Unique stem hung design does not require pipe sealant compound on fittings.
- 3/4" inner diameter rigid conduit or water pipe may be substituted for stems or goose necks.

RPAS

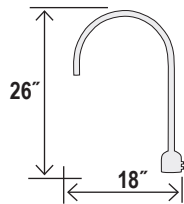
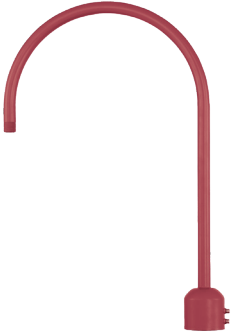

Finish & Material

Finishes	ABR - Architectural Bronze AL - Aluminum CP - Copper GA - Galvanized GY - Gray NB - Navy Blue SB - Satin Black SG - Satin Green SR - Satin Red WH - White
Material	Cold Rolled Steel, Die Cast Zinc

Certification

UL Listed Wet Location

Item Number

SKU RPAS

2 LIGHT POST ADAPTERS

- Will work with any RLM shade
- Designed to fit standard 3" posts and pier mount bases
- Unique stem hung design does not require pipe sealant compound on fittings.
- 3/4" inner diameter rigid conduit or water pipe may be substituted for stems or goose necks.

RPAD

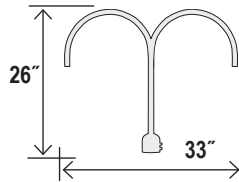

W: 33" x H: 26"

Finish & Material

Finishes	ABR - Architectural Bronze AL - Aluminum CP - Copper GA - Galvanized GY - Gray NB - Navy Blue SB - Satin Black SG - Satin Green SR - Satin Red WH - White
Material	Cold Rolled Steel, Die Cast Zinc

Certification

UL Listed Wet Location

Item Number

SKU RPAD