



Medley™

Single-handle bathroom sink faucet

27371-4

Features

- Single handle controls both on/off activation and temperature settings.
- 5" (127 mm) spout reach.
- 1.2 gpm (4.5 lpm) maximum flow rate at 60 psi (4.14 bar).
- KOHLER ceramic disc valves exceed industry longevity standards for a lifetime of durable performance.
- Clicker drain with tailpiece.
- Coordinates with other products in the Medley collection.

Material

- Premium metal construction for durability and reliability.
- KOHLER finishes resist corrosion and tarnishing.

Installation

- For single-hole or 4" (102 mm) center installation (escutcheon plate included).
- Deck-mount.
- Preattached flexible supply lines simplify installation.

Recommended Products/Accessories

- K-23726 Drain treatment
- K-23723 Faucet cleaner



ADA **CSA B651** **OBC**

Codes/Standards



ASME A112.18.1/CSA B125.1
NSF/ANSI 61
NSF/ANSI 372
All applicable US Federal and State material regulations
DOE - Energy Policy Act 1992
EPA WaterSense®
California Energy Commission (CEC)
ADA
ICC/ANSI A117.1
CSA B651
OBC

KOHLER® Faucet Lifetime Limited Warranty

See website for detailed warranty information.

Available Colors/Finishes

Color tiles intended for reference only.

Color	Code	Description
	CP	Polished Chrome
	BN	Vibrant® Brushed Nickel

1-800-STERLING (1-800-783-7546)

Kohler Co. reserves the right to make revisions without notice to product specifications.

For the most current Specification Sheet, go to www.sterlingplumbing.com.

4-15-2021 13:43 - US/CA

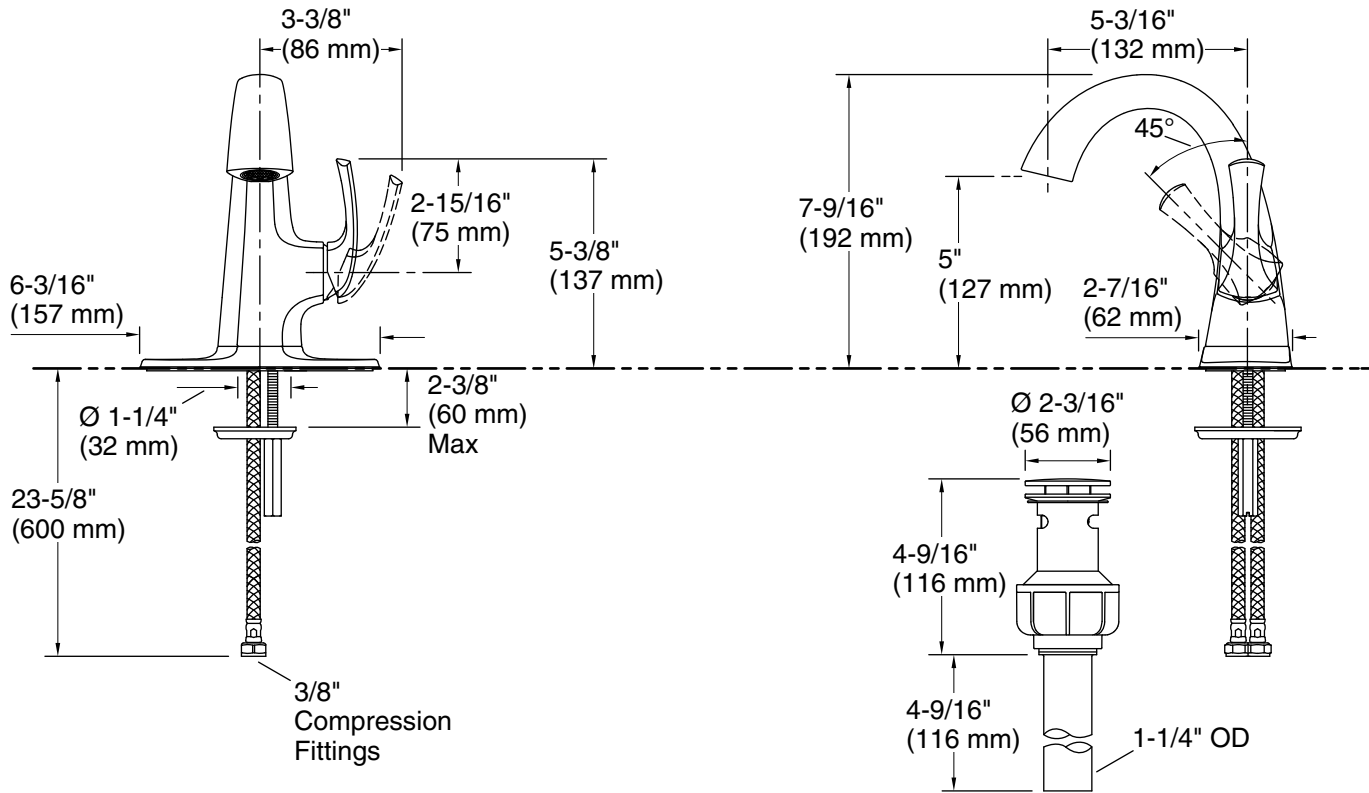

Technical Information

All product dimensions are nominal.

Faucet:

Flow rate: 1.2 gal/min (4.5 l/min)
 Pressure: 60 psi (4.1 bar)
 Valve body: Plastic
 Drain included: Yes

Spout:

Spout reach: 5-3/16" (132 mm)

Notes

Install this product according to the installation instructions.

ADA, OBC, CSA B651 compliant when installed to the specific requirements of these regulations.